

Berlin
Nonnendammallee 35
D-13599 Berlin
Fon: (030) 35 53 09-0
Fax: (030) 35 53 09-20
Mail: berlin@siteco.de

Frankfurt/Main
Rödelheimer Landstraße 13
D-60487 Frankfurt
Fon: (069) 97 09 74-22
Fax: (069) 97 09 74-11
Mail: frankfurt-main@siteco.de

Hamburg
Tarpfen 40 · Haus 1c
D-22419 Hamburg
Fon: (040) 53 71 20-50
Fax: (040) 53 71 20-77
Mail: hanse@siteco.de

Hannover
Dorfstraße 17
D-30519 Hannover
Fon: (0511) 87 41 52-3
Fax: (0511) 87 41 52-40
Mail: hannover@siteco.de

Köln
Vogelsanger Straße 80
D-50823 Köln-Ehrenfeld
Fon: (0221) 5 77 78-0
Fax: (0221) 5 77 78-90
Mail: nordrhein@siteco.de

Leipzig
Fuggerstraße 1
D-04158 Leipzig
Fon: (0341) 5 26 77-0
Fax: (0341) 5 26 77-20
Mail: leipzig@siteco.de

Lünen
An der Wethmarheide 34
D-44536 Lünen
Fon: (02306) 20 04-0
Fax: (02306) 20 04-20
Mail: ruhr@siteco.de

Mannheim
Josef-Meyer-Straße 13-15
D-68167 Mannheim
Fon: (0621) 3 97 01-0
Fax: (0621) 3 97 01-30
Mail: mannheim@siteco.de

München
Neumarkter Straße 80
D-81673 München
Fon: (089) 45 42 96-0
Fax: (089) 45 42 96-77
Mail: muenchen@siteco.de

Nürnberg
Allersberger Straße 185 G
D-90461 Nürnberg
Fon: (0911) 9 41 78-0
Fax: (0911) 9 41 78-31
Mail: nuernberg@siteco.de

Stuttgart
Rutesheimer Straße 24
D-70499 Stuttgart
Fon: (0711) 88 02 37-0
Fax: (0711) 88 02 37-30
Mail: stuttgart@siteco.de

Australia
International Lighting Pty Ltd
14 Hudson Avenue
Castle Hill NSW 2154
Fon: +61 2 9680 8466
Fax: +61 2 9680 8655
Mail: info@siteco.de

Austria
Siteco Österreich GmbH
Puchgasse 2
A-1222 Vienna
Fon: +43 1 2 50 24-0
Fax: +43 1 2 50 24-2 55
Mail: info@siteco.at

Belgium
C.T.R. s.a.
Rue J.B. Deckockstraat, 99-101
B-1080 Brussels
Fon: +32 2 410 50 10
Fax: +32 2 410 02 46
Mail: mschayer@ctr.be

Bosnia-Herzegovina
Siteco d.o.o.
Predstavništvo Sarajevo
Hamdije Cemerlića 2
BiH-71000 Sarajevo
Fon: +387 33 654 163
Fax: +387 33 654 814
Mail: siteco@bih.net.ba

China
Prosperity Lamps &
Components Ltd.
RM 1401-2 Habour Centre,
25 Harbour Road, Wanchai
Fon: +852 2511 0022
Fax: +852 2511 0082
Mail: info@siteco.de

Croatia
Siteco d.o.o.
Predstavništvo
u Republici Hrvatskoj
Trg Dražena Petrovića 3
CRO-1000 Zagreb
Fon: +385 1 48 12 417
Fax: +385 1 48 43 588
Mail: siteco@inet.hr

Czech Republik
Siteco Österreich GmbH
Kostelní 25/25
CZ-25088 Čelákovice
Fon: +420 326 991 409
Fax: +420 326 996 480
Mail: info@siteco.at

Denmark
Siteco Belysning AS
Ole Deviks vei 4
N-0666 Oslo
Fon: +47 23 37 32-50
Fax: +47 23 37 32-60
Mail: info@siteco.de

Eritrea
D.M. Electrical
Engineering P.L.C.
PO Box 5783
Asmara
Fon: +291 1 184816
Fax: +291 1 188638
Mail: info@siteco.de

Ethiopia
Siemens Pvt.Ltd.
PO Box 5505
Addis Ababa
Fon: +251 1 511599
Fax: +251 1 515999
Mail: info@siteco.de

Finland (Indoor luminaires)
Pejan Oy
Matinpurontie 8
FIN-02230 Espoo
Fon: +358 9 819 0100
Fax: +358 9 802 4566
Mail: info@pejan.fi

Finland (Outdoor luminaires)
Silux OY AB
Ulappakatu 1
FIN-02320 Espoo
Fon: +358 9 80 22 077
Fax: +358 9 80 21 890
Mail: info@silux.fi

France
Siemens S.A.S.
39/47, boulevard Ornano
F-93527 Saint-Denis Cedex 2
Fon: +33 1 4922 35 74
Fax: +33 1 4922 38 18
Mail: info@siteco.de

Greece
Siemens A.E.
Artemidos 8 - PO Box 61011
GR-151 10 Amaroussio/Athen
Fon: +30 1 6864 578
Fax: +30 1 6864 562
Mail: info@siteco.de

Hungary
Siteco Österreich GmbH
Puchgasse 2
A-1222 Vienna
Fon: +43 1 2 50 24-209
Fax: +43 1 2 50 24-255
Mail: info@siteco.at

Indonesia
PT Sielltec Cahaya Tuggal
Kompleks Ferry Sonnevile
Blok IV Kavling D1/D2
Gumung Putri - Bogor 16961
Fon: +62 21 867 1461
Fax: +62 21 867 1743
Mail: info@siteco.de

Ireland
Siteco Ltd, Units 7 & 8
Hillgate Business Centre
Swallow Street, Higher Hillgate
GB-Stockport SK1 3AU
Fon: +44 161 480 6558
Fax: +44 161 480 6559
Mail: info@siteco.co.uk

Israel
Nisko Import
Electricity & Electronics Ltd.
2a Habarzel St. Tel-Aviv 69710
Fon: +972 3 7657216
Fax: +972 3 7657222
Mail: info@siteco.de

Italy
Siteco Lighting Systems S.r.l.
Via Pollini 8
I-20126 Milan
Fon: +39-0266-11-7107
Fax: +39-0266-11-3056
Mail: info@sitecoitalia.it

Korea
Osram Korea Co. Ltd
3rd Fl, Ye-Sung Bldg, 150-30
Samsung-dong, Kangnam-ku
Seoul (135-090)
Fon: +82 2 5544 112
Fax: +82 2 556 1644
Mail: info@siteco.de

Kuwait
NGECCO National & German
Electrical and Electronic
Services Company
PO Box 6612; 32041 Hawalli
Fon: +965 2418888
Fax: +965 2463222
Mail: info@siemens.com.kw

Luxembourg
MINUSINES S.A.
8, rue Hogenberg
L-1022 Luxembourg
Fon: +352 49 58 58
Fax: +352 49 58 66
Mail: michels@minusines.de

Malaysia
Siteco Lighting (M) Sdn Bhd
No 18 & 20; Jalan Utama 2/20
Taman Perindustrian Puchong
Utama
47100 Puchong
Selangor Darul Ehsan
Fon: +603 8062 2426
Fax: +603 8062 2439
Mail: info@siteco.com.my

-16-
-14-
-12-
-10-
-8-
-6-
-4-
-2-
LPH (m)



Top in form.

Now light goes
undercover.

office

industry

traffic

shopping

public

sports

DL® 800 Luminaires.

Netherlands
Candela Lichttechniek b.v.
Postbus 8
NL-2950 AA Alblasserdam
Fon: +31 78 6 920 929
Fax: +31 78 6 920 920
Mail: info@candela.nl

Nigeria
Siemens Ltd, Nigeria
98/100 Oshodi
Apapa Lagos
Fon: +234 1 4500237
Fax: +234 1 4500131
Mail: info@siteco.de

Norway
Siteco Belysning AS
Ole Deviks vei 4
N-0666 Oslo
Fon: +47 23 37 32-50
Fax: +47 23 37 32-60
Mail: siteco@siteco.no

Oman
Waleed Associates LLC
PO Box 437 Muscat P.C. 113
Fon: +968 713313 / 713211
Fax: +968 715042
Mail: info@siteco.de

Poland
Siteco Lighting Poland Sp. z o.o.
ul. Poleczki 21
PL-02-822 Warsaw
Fon: +48 22 545 05 83
Fax: +48 22 545 05 84
Mail: siteco@siteco.com.pl

Portugal
Siemens S.A.
A & D Iluminação
Rua Irmaõs Siemens, 1
P-2720-093 Amadora
Fon: +351 21 417 82 69
Fax: +351 21 417 80 89
Mail: info@siteco.de

Russia
Siteco Beleuchtungstechnik
Tverskoy Bulvar, 14/1
RUS-103009 Moskwa
Fon: +7 501 792 5374
Fax: +7 501 792 5302
Mail: oleg@siteco.doi.ru

Singapore
Siteco Lighting (S) Pte Ltd
49 Jalan Pemimpin
#03-05 APS Industrial Building
Singapore 577203
Fon: +65 255 2325
Fax: +65 255 1890
Mail: info@siteco.de

Serbia and Montenegro
Siteco d.o.o.
Predstavništvo
Bul. A. Carnojevića 35
SCG-11070 Novi Beograd
Fon: +381 11 130 388
Fax: +381 11 130 388
Mail: godjevac@siteco.co.yu

Slovakia
Siteco Österreich GmbH
Puchgasse 2
A-1222 Vienna
Fon: +43 1 2 50 24 307
Fax: +43 1 2 50 24 255
Mail: info@siteco.at

Slovenia
Siteco d.o.o.
Trzaska c. 23
SLO-2000 Maribor
Fon: +386 2 300 4200
Fax: +386 2 332 5234
Mail: info@siteco.si

Spain
Siemens S. A., PS 8
Ronda de Europa 5
E-28760 Tres Cantos (Madrid)
Fon: +34 91 514 7050
Fax: +34 91 514 7016
Mail: info@siteco.de

Sweden (Indoor luminaires)
Annell Ljus + Form AB
Surbrunnsgatan 14
S-11421 Stockholm
Fon: +46 8 442 90 00
Fax: +46 8 442 90 25
Mail: info@annell.se

Sweden (Outdoor luminaires)
ScandiDelux Belysning AB
Postbox 22562
S-10422 Stockholm
Fon: +46 8 785 0002
Fax: +46 8 785 0005
Mail: info@siteco.de

Switzerland
Siteco Schweiz AG
Airport Business Center 62
CH-3123 Bern-Belp
Fon: +41 31 818 28 28
Fax: +41 31 818 28 20
Mail: info@siteco.ch

Taiwan
Lancaster Co. Ltd
No 323 Sung Shan Rd
Taipei
Fon: +8862 2 764 9516
Fax: +8862 2 765 4725
Mail: info@siteco.de

Turkey
Siteco Aydinlatma Teknigi
Gardenya Plaza 3
Kat. 10
TR-81120 Ataşehir-Istanbul
Fon: +90 216 455 4565
Fax: +90 216 455 4073
Mail: siteco@siteco.com.tr

UK
Siteco Ltd, 7 & 8 Hillgate
Business Centre
Swallow Street, Higher Hillgate
GB-Stockport SK1 3AU
Fon: +44 161 480 6558
Fax: +44 161 480 6559
Mail: info@siteco.co.uk

Ukraine
A2 Design LLC
Zhilyanskaya str. 30/32, r. 42
UA-01033 Kiev
Fon: +38 044 4619288
Fax: +38 044 4619287
Mail: info@a2.com.ua

United Arab Emirates
ARASCA Arabian Scandinavian
General Trading Co.
PO Box 86637 Dubai
Fon: +971 4 3391337
Fax: +971 4 3391335
Mail: arasca@emirates.net.ae

More light? More info?
Siteco Beleuchtungs-
technik, Ohmstraße 50,
D-83301 Traunreut,
Germany.
Fon: +49 8669/33-0
Fax: +49 8669/33-397
Mail: info@siteco.de
Surf: www.siteco.de

siteco lighting systems

Individually designed
urban lighting systems –
bringing towns to life!

siteco You will see.



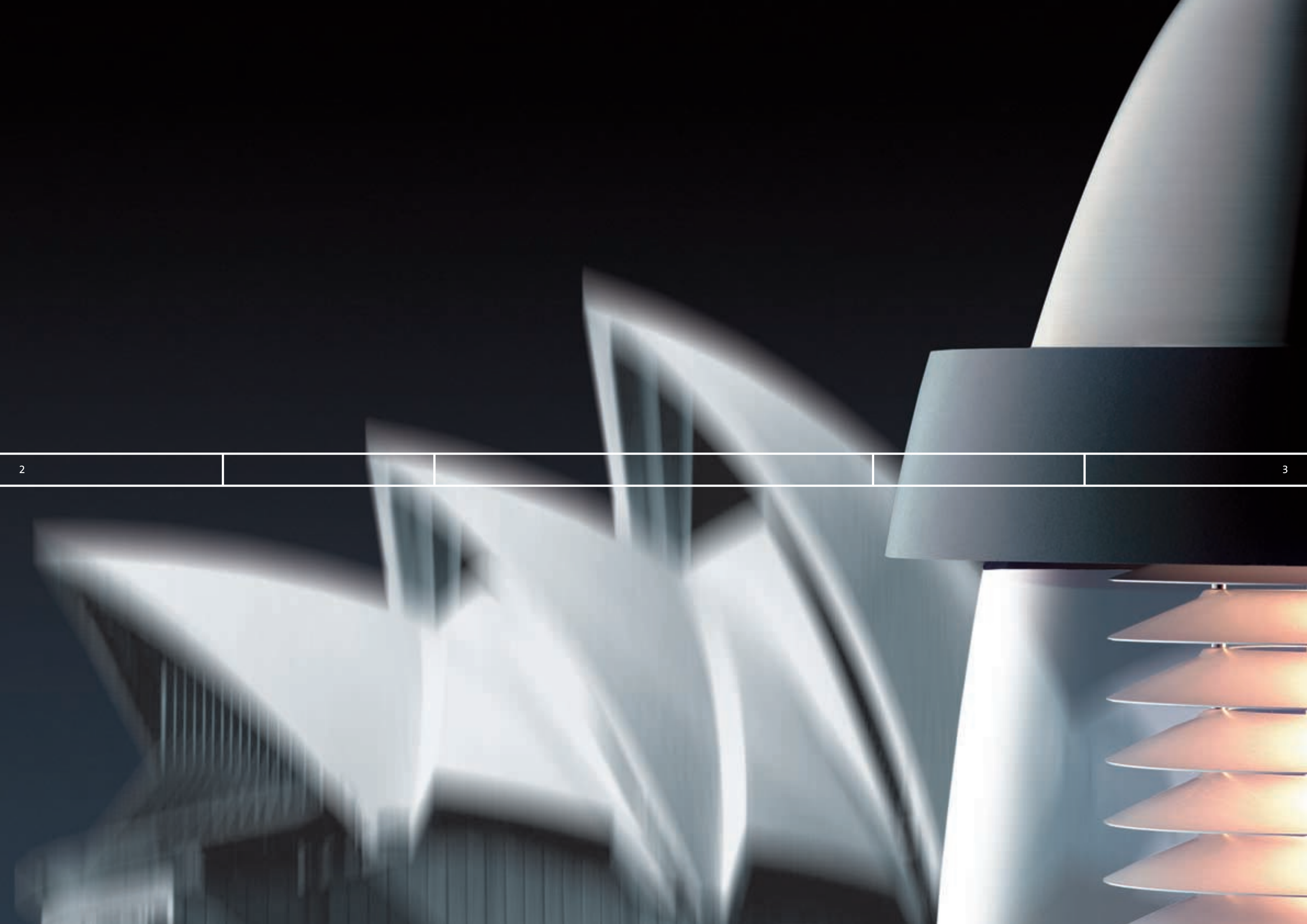



4



5

Curve meets edge.

Towns. People. Lights. Lighting shapes the character of our urban spaces and has a direct effect on the way we feel.

A town's character can be changed by this luminaire design: the hood and trough of the Siteco DL[®]800 luminaire reach upward in a parabola intersected horizontally by a solid ring mounting. The contrast of curve and right angle, transparency and solid material create a suspended effect.

The effect: inspiring.
Areas of use: unlimited.

Siteco DL[®]800. The shape of quality.

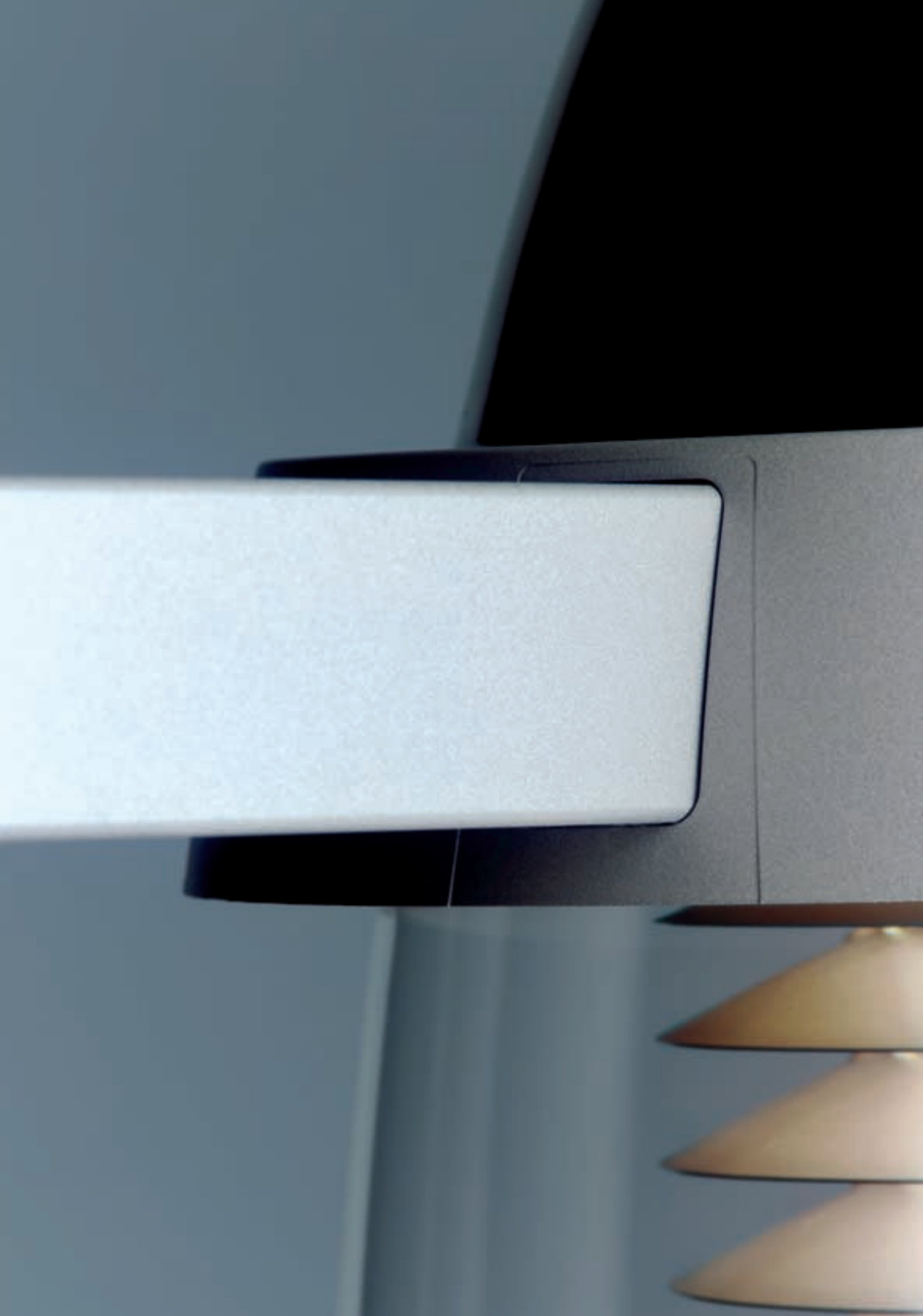
**Natural. Exciting.**

The DL®800 uses natural materials: Aluminium die-casting and anodized aluminium, stainless steel, clear or satin-frosted glass (PMMA). Perfect, smooth surfaces, flawlessly fashioned joints and connections – quality you can see and touch.

Siteco DL®800 luminaires are rotationally symmetrical. However they are turned or rotated, every perspective shows them at their most visually exciting.

The upper neck of the mast forms part of the luminaire. Result: a lantern and mast in perfect harmony – and no assembly costs!

Siteco DL®800. Attractive all round.



Harsh climate? No problem!
The DL®800 is filigree, yet robust. With protection class IP66 it is guaranteed dustproof and water jet-proof.

In the Siteco laboratory we have tested the DL®800 against heavy rain and simulated severe traffic vibration. The result: the DL®800 is guaranteed to remain unruffled by the modern urban environment and the harshest of weathers.

The cover on the edge of the trough is offset slightly upward. This harmonious design feature acts like a drip rim; it also increases the impact strength of the luminaire well beyond the required standards and increases protection against damage caused by vandalism.

Siteco DL®800. Unshakeably good design.

SITECO



10

Highlight in every situation.

The DL®800 feels completely at home even in a small town. It is so adaptable that it provides a completely individual design for any urban space: pedestrian zones, parks, car parks, paths and streets.

We have developed various masts and cantilevers, hood variants and trough types for a great appearance in every situation. The look of the DL®800 comes courtesy of a hood and trough made of clear glass (PMMA). The DL®800 with its stainless steel hood reflects the sky and with a hood made of dull-anodized aluminium the DL®800 gives an overall cast appearance.

The curved DL®800 design mast assumes the characteristic shape of the lantern and lends it a unique and attractive day-light effect.



11

Light to measure.

More light? The standard mast comes with single cantilever bracket or a 2-arm design with the option to select the more styled curved mast. Lighting variants like the fan-shaped reflector or the asymmetrical reflector diffuse the light onto the surrounding area with a uniform quality.

Warm lamp colours attract people. Nocturnal animals, on the other hand, are left cold by warm light – so that the DL®800 makes towns more attractive while protecting the environment!

Siteco DL®800. A light that attracts people.



Foto: image2d.com



1 on standard mast 2 on design mast (from 05/2004 on request) 1 on design mast (180° twisted arrangement also possible) 2 on standard mast

Housing modules	
1	Supporting framework with aluminium hood, anodized
2	Supporting framework with aluminium hood, Siteco micaceous iron ore (DB702S)
3	Supporting framework with stainless steel hood, rust-free
4	Supporting framework with PMMA hood, transparent
Electrical unit	
5	Electrical operation for hanging lamp, 2G8 lamp holder
6	Electrical operation for hanging lamp, E27 lamp holder
7	Electrical operation for hanging lamp, 2G11 lamp holder
Lighting modules	
8	Pagoda reflector P2
9	Pagoda reflector with P2H screen shield on facade side
10	Asymmetrical reflector A1
11	Fan-shaped reflector, short, long F1/F2
12	Fan-shaped reflector, short, long with F1H/F2H screen shield on facade side
13	Screen shield on facade side
Cover variants	
14	Clear trough, made of PMMA
15	Satin-frosted trough, made of PMMA

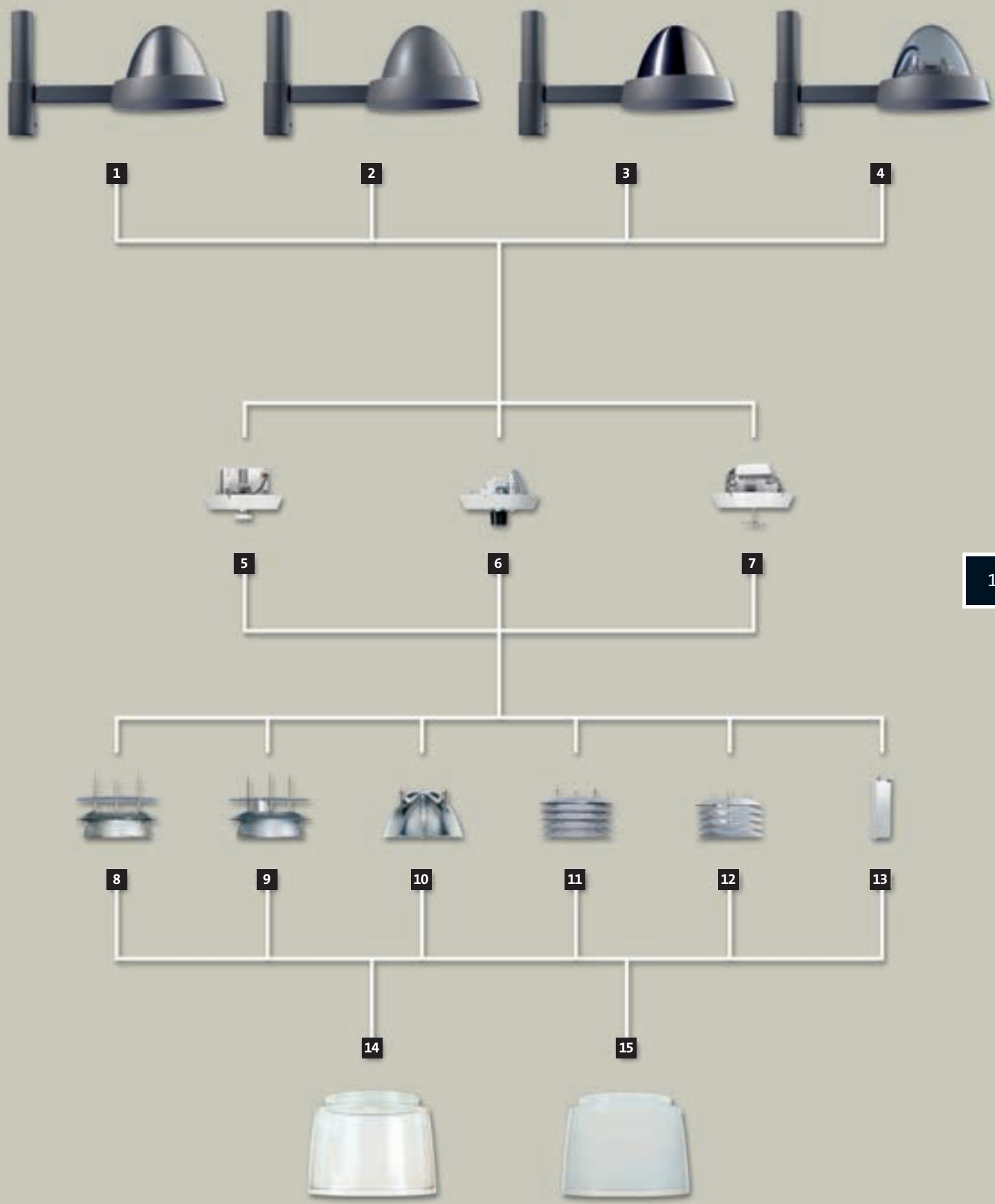

ORDER DATA

Masts

Order number	Description	Width	Height	Spigot diameter	Material	Surface
5NY 152 74 5K 1M08	Design mast, offset, 1-arm	424 mm	4500 mm	76 mm (mast top mounting)	Steel, galvanized	Siteco micaceous iron ore (DB702S)
5NY 152 74 5K 2M08	Design mast, offset, 2-arm	424 mm	4500 mm	76 mm (mast top mounting)	Steel, galvanized	Siteco micaceous iron ore (DB702S)
5NY 231 74 5K M08	Standard mast, conical		4500 mm	76 mm (mast top mounting)	Steel, galvanized	Siteco micaceous iron ore (DB702S)

Reflectors

Order number	Description
5NA 140 00XS2	Pagoda reflector
5NA 140 00XS21	Pagoda reflector with screen shield on facade side
5NA 140 00XS3	Fan-shaped reflector, short (18 W)
5NA 140 00XS31	Fan-shaped reflector, short (18 W) with screen shield on facade side
5NA 140 00XS4	Fan-shaped reflector, long (24 W)
5NA 140 00XS41	Fan-shaped reflector, long (24 W) with screen shield on facade side
5NA 140 00XS5	Asymmetrical reflector
5NA 140 00XB0	Shade

Lamps for new 2G8 lamp holder

Order number	Lamp	Wattage	Light colour	Colour temperature
5PD 401 60W	PL-H 4P (Philips)	60 W	830	3000 K
5PD 402 85W	PL-H 4P (Philips)	85 W	830	3000 K
5PD 401 60C	PL-H 4P (Philips)	60 W	840	4000 K
5PD 402 85C	PL-H 4P (Philips)	85 W	840	4000 K

Further lamps for standard lamp holders E27 and 2G11 can be found in the current Siteco illustrated price list.

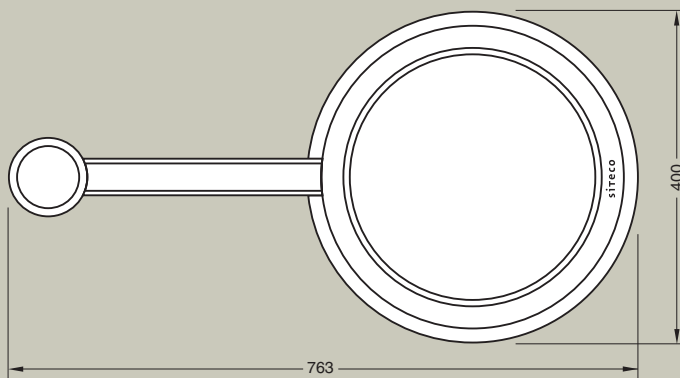
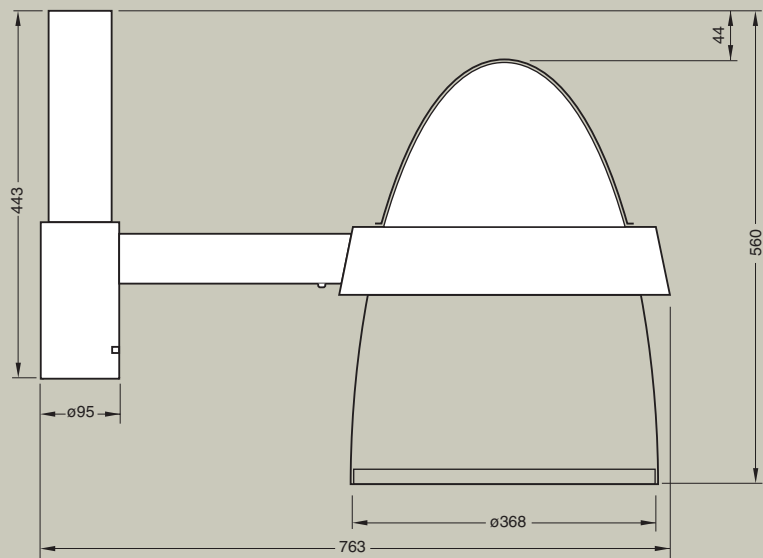

Spigot

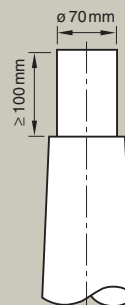

Design light.

The Philips PL-H belongs to the latest generation of lamps for street lighting. The new lighting medium is

- **aesthetic:** attractive lamp colour and very good colour reproduction generate vibrant lighting moods
- **economical:** higher energy yield and long service life with constantly high lighting current
- **secure:** stable spigot bayonet connector for a sturdy lamp holder

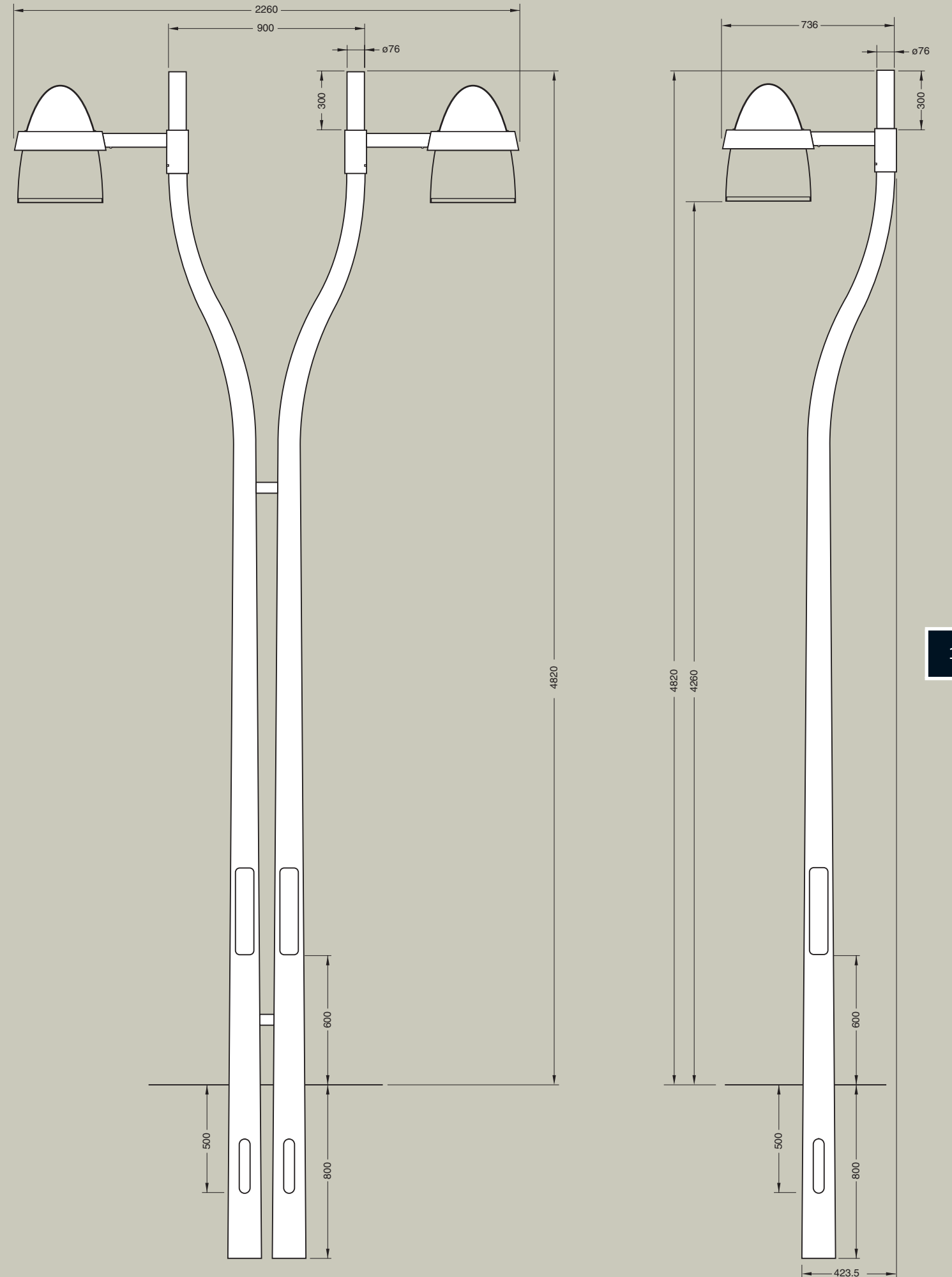

LIGHT CHARACTERISTICS

DL 800 (5NA 152 E-1QA11A08) 1 x HIE 150 W C0-180 C90-270 LPH = 3m N = 0° LPH = 4,5m N = 0°

- Pagoda reflector (5NA 140 0-0XS2)
- Clear trough and glass
- Wide, circular

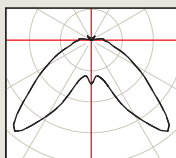
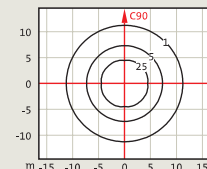
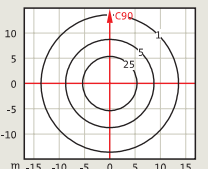
DL 800 (5NA 152 E-1QA11A08) 1 x HIE 150 W C0-180 C90-270 LPH = 3m N = 0° LPH = 4,5m N = 0°

- Pagoda reflector with screen shield on facade side (5NA 140 0-XS21)
- Clear trough and glass
- Wide, asymmetrical

DL 800 (5NA 152 E-1QA11A08) 1 x HIE 150 W C0-180 C90-270 LPH = 3m N = 0° LPH = 4,5m N = 0°

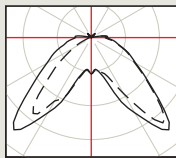
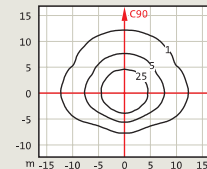
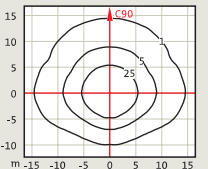
- Asymmetrical reflector (5NA 140 0-0XS5)
- Clear trough and glass
- Wide beam

DL 800 (5NA 152 E-1MA11A08) 1 x HSE 50 W C0-180 C90-270 LPH = 3m N = 0° LPH = 4,5m N = 0°

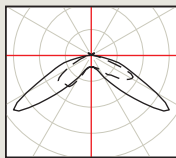
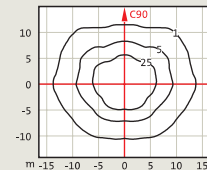
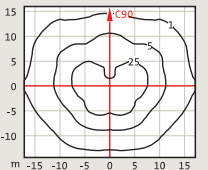
- Asymmetrical reflector (5NA 140 0-0XS5)
- Clear trough and glass
- Wide beam

DL 800 (5LA 152 7-1KB11A08) 1 x PL-H 85 W C0-180 C90-270 LPH = 3m N = 0° LPH = 4,5m N = 0°

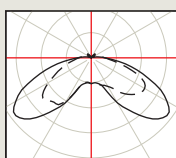
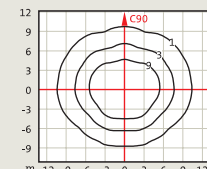
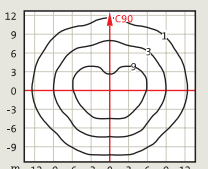
- Fan-shaped reflector (5NA 140 0-0XS4)
- Clear trough and glass
- Wide, circular

DL 800 (5LA 152 7-2KG11A08) 2 x TC-L 24 W C0-180 C90-270 LPH = 3m N = 0° LPH = 4,5m N = 0°

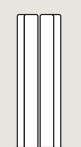
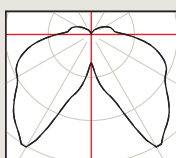
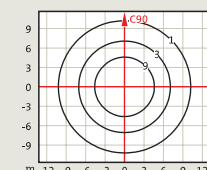
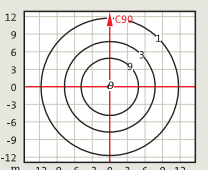
- Fan-shaped reflector with screen shield on facade side (5NA 140 0-0XS41)
- Clear trough and glass
- Wide, asymmetrical

Protect and save.
DL®800 luminaires are equipped with economical Siteco Savelight components: **Siteco Savelight control gear** with thermal protection switch off safely in the event of lamp defects and therefore avoid an unacceptably high temperature build-up.

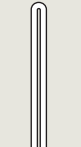
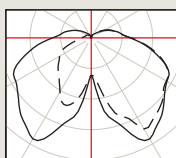
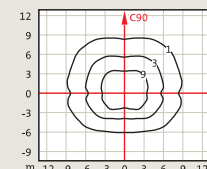
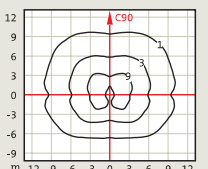
Siteco Savelight reducer relays with timer halve the illumination during slack periods, reducing energy consumption by some 25 per cent. The lamps always start under full load – even after a supply voltage interruption or when switching on in reduced mode – saving the lamps and guaranteeing the defined light intensity. **Siteco Savelight ignitors** with automatic switch-off reduce electromagnetic faults during the ignition process and simplify localisation of defective lamps. Automatic switch-off increases the service life of the ignitor.

Siteco Savelight. Certainly less cost.



Light for people and environment.
The development of the DL®800 lanterns maintains the Siteco “Integrated Product Policy – Action for Product-related Environmental Protection” initiative of the Bavarian Environment Ministry. The integrated product policy is aimed at optimising products and their related services in terms of their impact on people and their environment during the whole product path.

Siteco. Lighting of the future.